

Installation - operating - servicing



MB – boilers

35 – 45 – 60 – 75 – 90

105 - 120 - 140 - 150 kW

Technical data

Model	MB 35	MB 45	MB 60	MB 75	MB 90
Power	35 kW	45 kW	60 kW	75 kW	90 kW
Nominal supply voltage					
Power circuit	3 x 400 V	3 x 400 V	3 x 400 V	3 x 400 V	3 x 400 V
Control circuit	1 x 230 V 50/60 Hz	1 x 230 V 50/60 Hz	1 x 230 V 50/60 Hz	1 x 230 V 50/60 Hz	1 x 230 V 50/60 Hz
Amps	51 A	65 A	87 A	108 A	130 A
Number of elements	4	4	7	7	7
Temp.controller (steps)	7	7	7	7	7
Temp. range	30 – 95 °C	30 – 95 °C	30 – 95 °C	30 – 95 °C	30 – 95 °C
Water contents (liters)	75	75	75	75	75
Tube connections					
Outlet/inlet	DN 65/16	DN 65/16	DN 65/16	DN 65/16	DN 65/16
Expansion/drain	1"	1"	1"	1"	1"
Water circulation $\Delta t = 20\text{ °C}$ (m ³ /h)	1,5	1,9	2,6	3,2	3,9
Pressure drop(kPa)	0,02	0,03	0,05	0,07	0,10
Water speed(m/s)	0,11	0,14	0,19	0,23	0,28
Max. working pressure	6 bar	6 bar	6 bar	6 bar	6 bar
Min. working pressure	1 bar	1 bar	1 bar	1 bar	1 bar
Dimensions size (cm)					
Height	128	128	128	128	128
Width	38	38	38	38	38
Depth	69	69	69	69	69
Weight empty, (kg)	130	130	135	135	140

Technical data

Model	MB 105	MB 120	MB 140	MB 150
Power	105 kW	120 kW	140 kW	150 kW
Nominal supply voltage				
Power circuit	3 x 400 V	3 x 400 V	3 x 400 V	3 x 400 V
Control circuit	1 x 230 V 50/60 Hz	1 x 230 V 50/60 Hz	1 x 230 V 50/60 Hz	1 x 230 V 50/60 Hz
Amps	152 A	173 A	202 A	217 A
Number of elements	7	7	7	8
Temp.controller (steps)	7	7	7	7
Temp. range	30 – 95 °C	30 – 95 °C	30 – 95 °C	30 – 95 °C
Water contents (liters)	75	75	75	75
Tube connections				
Outlet/inlet	DN 65/16	DN 65/16	DN 65/16	DN 65/16
Expansion/drain	1"	1"	1"	1"
Water circulation $\Delta t = 20\text{ °C}$ (m ³ /h)	4,5	5,2	6,0	6,5
Pressure drop(kPa)	0,14	0,18	0,24	0,28
Water speed(m/s)	0,33	0,37	0,43	0,47
Max. working pressure	6 bar	6 bar	6 bar	6 bar
Min. working pressure	1 bar	1 bar	1 bar	1 bar
Dimensions(cm)				
Height	128	128	128	128
Width	38	38	38	38
Depth	69	69	69	69
Weight empty, (kg)	145	150	150	155

MB 35 – 150 kW



- 1. Temp. controller
- 2. Safety temp .limiter
- 3. ON/OFF –switch
- 4. Contactors
- 5. Fuses/circuit breakers
- 6. Bus bars for connecting
Supply cables
- 7. Drain
- 8. Return
- 9. Flow
- 10. Expansion

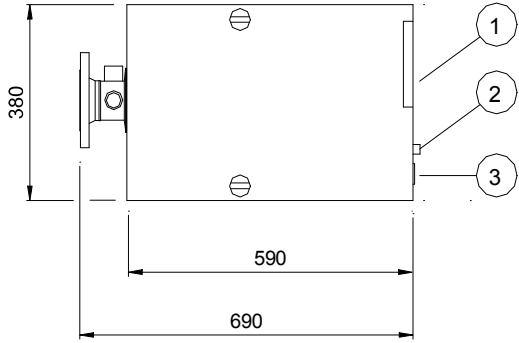
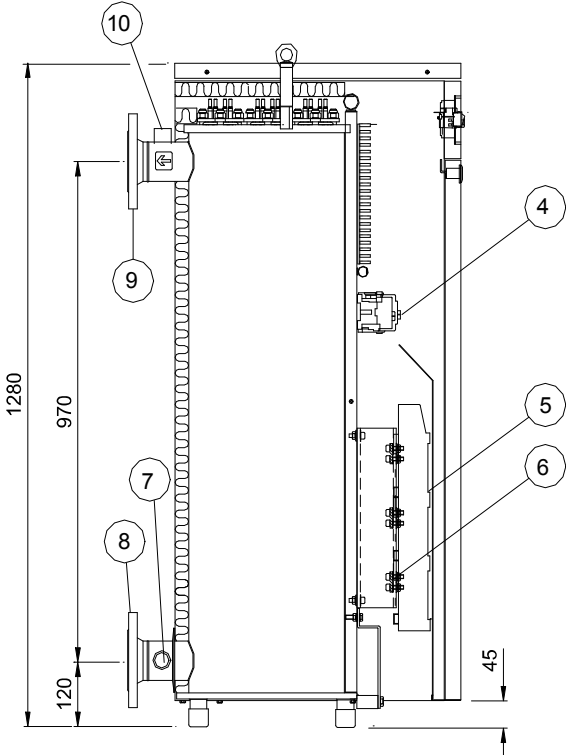

Content

Technical data	2
General information	
Installation	6
Pressure safety valve	6
Connection	6
Control voltage	6
Commissioning	
Start up	7
Temperature controller	7
Settings	8
Additional functions	9
Remote control	
Boiler Start/stop	10
Temperature control	10
Power control	10
Monitoring	
Operation signal	11
Failure signal	11
Output signals 0-10 V	11
Terminal block	11
Menus	12
Maintenance	13
Troubleshooting	14
Circuit diagrams	
Control circuit	15
Power circuit	16
Temp. controller	
Terminals	17
Spare parts	18

Installation

THE BOILER MUST BE POSITIONED IN SUCH A WAY THAT IT DOES NOT PREVENT PERFORMANCE OF SERVICE AND MAINTENANCE.

Required free height above the boiler for disassembly of heating elements is 1 m. Front and at least one side should be free in order to perform service and maintenance.

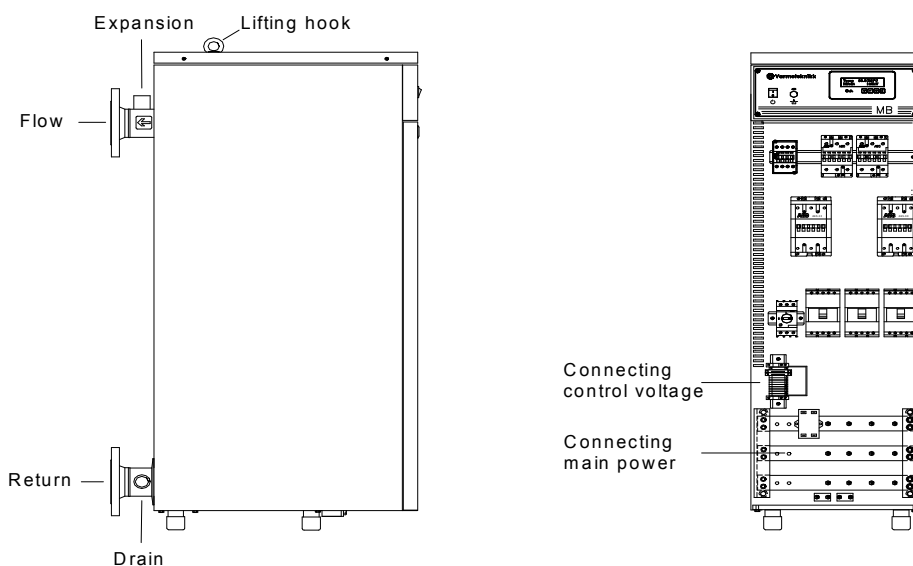

Pressure safety valves

The boiler must be equipped with pressure safety valves. The pressure safety valves should be placed as close as possible to boiler and it should not be any shutoff between the valves and the vessel. The opening pressure must not exceed maximum operating pressure of the boiler. To avoid damage a pipe pointing down towards the floor, should be fixed to the pressure safety valves.

Connection

NOTE! INSTALLATION MUST ONLY BE EXECUTED BY QUALIFIED PERSONNEL

All applicable regulations must be observed when electrical and plumbing connections. Sufficient provision must be made for expansion, in accordance with applicable regulations

Supply cables

Connect supply cables to the bus bars by using a ring terminal or suitable cable clamps. Two earth clamps is located in bottom of the switch gear for earth cables.

Control voltage

220-230V control voltage is required. Connection to be done on F1 & F2 on the terminal block inside the boiler. See page 11.

Commissioning

Note! BEFORE SWITCHING ON THE BOILER CHECK THE FOLLOWING:

- Check that the water system is completely filled with water. To prevent heating element break down make sure there is no air pockets in plant.
- Switch on circulating pump and check water flow and direction.
- Hydraulic expansion system has to be controlled. Min. pressure, 1bar.
- Check for correct supply voltage

Note! Before start up, retighten all electrical connections.



Don't switch on the boiler if there is a possibility that the water in boiler is frozen.

This appliance is not intended for use by persons (including children) with reduced physical, sensory or mental capabilities or lack of experience and knowledge, unless they have been given supervision or instruction concerning use of the appliance by a person responsible for their safety.

Children should be supervised to ensure that they do not play with the appliance.

Start up

Switch on the boiler by using the ON/Off-switch on the front panel. Display will after a few seconds show actual water temp., preset temp. in brackets. The line below shows connected power. Boiler will now step by step increase power to obtain preset temperature.

The temperature is factory set at 80 °C, and step time is set to 40 sec. Unless corrections of preset temperature or step time are required, no further adjustments are needed.



Note! If boiler is controlled by external signals, missing signal can prevent boiler from running.

Temperature controller

The boiler is equipped with a 7-steps electronic temperature controller located in front of the boiler. All settings can be done at the front. The controller has a proportional and integrating control and is designed to maintain constant boiler temperature. Temperature range is from 5 – 95 °C in steps by 1 °C. 3 relays control the power contactors which are connected in a binary order. This gives a high degree of reliability

If a failure occurs, an alarm diode starts flashing. Type of failure will be shown in display and could be:

Error temp: Temperature sensor is broken
Alarm net: Control voltage < 190 V
Alarm power: Power supply missing*

* *Alarm power* is activated if controller when reaching step 3, doesn't measure any power. The reason for this could be that main switch/circuit breaker on the switch board is OFF, security temp. limiter (STB) released because of high temperature, heating element/fuse is broken, or contactor is not connected.

Settings



Failure Menu button Enter button

Preset temperature:

Temperature range is from 30 – 95 °C. Preset temperature is factory set to 80 °C. If correction is needed do the following:
 Press + or – button to set desired temperature. Then press enter to save new value.

Step time:

Step time is adjustable between 20-250 sec. (factory setting is 40 sec.) and refer to connection of power steps. When disconnecting power, step time is 5 sec. with step time below 60 sec., 10 sec with step time above 60 sec. If correction is required do the following: Press menu button once to enter step time limitation mode. Then press + or – button. To enter step time mode press menu button. With +/- button choose desired step time. Press E button to save new value.



To return to temp/power mode, press menu button.

Additional functions

The temp. controller has been provided with a large number of other functions in addition to several possibilities for remote control.

Remote boiler in/out

The temp. controller is equipped with a potential free input for start/stop of the boiler. The disconnecting signal can be either an "OFF" or an "ON" switch. With a clamp on the PCB the temp. controller can be adjusted to either type of signal (see page 30). If start signal is missing display shows:

Step S	0 (0)
Step time	40s

See page 11 for connecting start/stop signal.

Power limitation

The maximum output of the boiler can easily be limited. It is only possible to limit the boiler on a whole step base. Limitation can be done in the menu or on a potentiometer located on the PCB.

Limitation in menu:

Enter Step mode and press – button. Choose number of power steps and then press **E** button to save new value.

Step lim	0(30)
Step time	40s



Step lim	0(25)
Step time	40s

For limitation on the PCB, see page 17

Outdoor temperature compensator

The temp. controller is prepared for outdoor temperature compensation. If outdoor sensor is connected, boiler will calculate and set flow temperature depending on outdoor temperature. Both curve and parallel are available for fine-tuning flow temperature. When outdoor sensor is connected, display shows:

TempU	47.0 (50)°C
Power	60kW

Temperature in brackets is calculated flow temperature depending on outdoor temperature. It is not possible to change calculated temperature when outdoor sensor is connected.

Outdoor t.	24°C
Parallel	0°C

For further information, contact Varmeteknikk.

Remote control by external signals

The boiler offers several possibilities for remote control. With a start/stop signal (potential free), boiler can be connected/disconnected from running. Maximum output or preset temperature can be controlled by a 0 - 10 V DC signal.

Remote start/stop of boiler

Boiler can be switched On/Off by an external signal. Before connecting signal, remove bridge on terminal 1 & 2, see next page. If start/stop-signal is connected and boiler gets start signal, display shows:

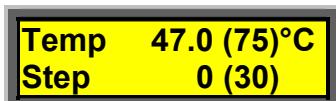

Temp 47.0 (75)°C
Step 0 (30)

If start signal is missing,
display shows:

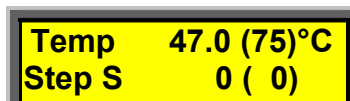

Temp 47.0 (75)°C
Step S 0 (0)

Temperature control by 0 – 10 V signal

Desired temperature can be controlled by a 0 – 10 V DC signal. 0 V = 0°C, 10 V = 100 C°. Normal temp. range is from 5 – 95°C, equivalent to 0 - 9,5V. Connection on terminal 30(-) and 31(+) on PCB (see page 17). Signal must be activated in service menu, see page 12. "Temp IN" must be set in "ON" position. Press + button twice and then E to enter new value.



Temp IN
ON

Press menu button twice to return to "Temp/Power" mode. When signal is activated display shows:

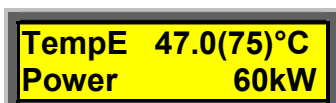

TempE 47.0(75)°C
Power 60kW

Note! When desired boiler temperature is controlled by a external 0 – 10 V signal, internal set point must be set as high as boiler should work. Internal thermostat is now working as a maximum thermostat and limit the temperature. This must be done before signal is activated.

Power control by 0-10V signal

Boiler output can be controlled by a 0 – 10 V DC signal. 0 V = 0 step, 10 V = all steps (15/30). Connection on terminal 29(+) and 30(-) on PCB (see page 17). Signal must be activated in service menu, see page 12. "Power IN" must be set in "ON" position. Press + button twice and then E to enter new value.



Power IN
ON

Press menu button twice to return to "Temp/Power" mode. When signal is activated display shows:



StepE 3 (7)
Step time 40s

Monitoring

Boiler is prepared for output digital signals to a central monitoring system. The signal contacts are wired to a terminal block inside the boiler. The outlet signals are:

Operation signal: indicates boiler is **ON** connection on terminal 3 & 4.

Failure: indicates STB released, sensor broken or control voltage < 190V. Connection on terminal 5 & 6. Type of error is shown in display.

Output 0-10V DC signals:

External power indication: 0 V = 0 kW, 10 V = Max kW (terminal 36 & 39)
 External temp.indication: 0 V = 0 °C, 10 V = 100 °C (terminal 36 & 38)
 External preset temperature: 0 V = 0 °C, 10 V = 100 °C (terminal 36 & 37)

Connection diagram, see page 17.

Terminal block inside boiler

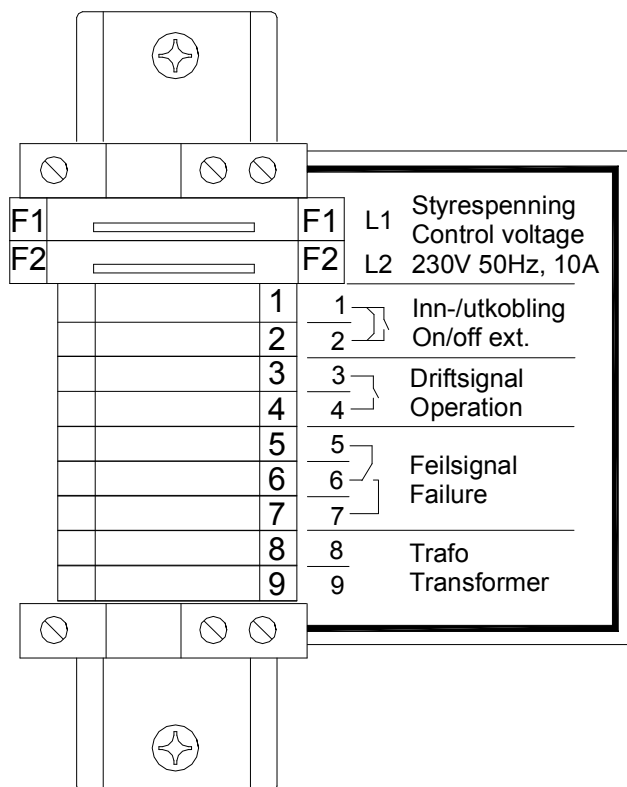

Menus

By pressing menu button, different modes appears

Start up:

EL 7	v1725
------	-------

El 15: 7-steps controller
V1725: version

Main menu

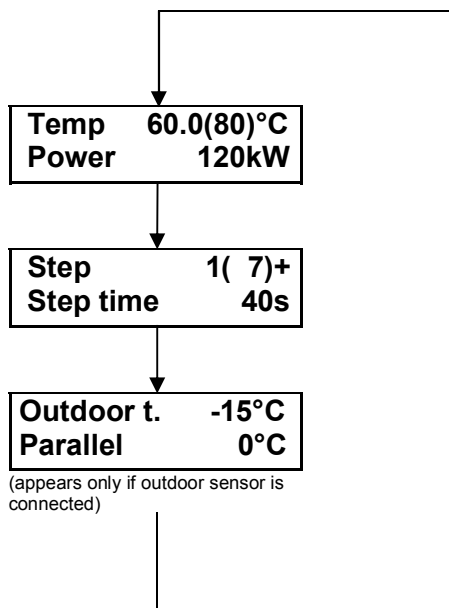

Settings in main menu:

- Desired temperature
- Number of power steps
- Step time

Service menu

To get access to service menu, press and hold menu button for more than 5sec.

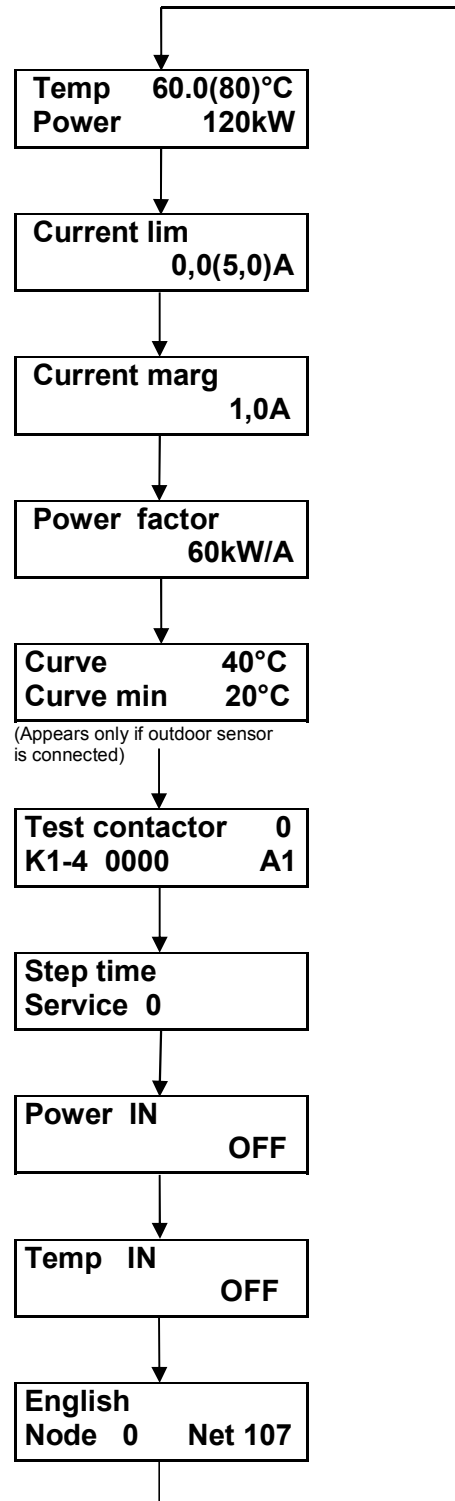

Maintenance

NOTE!

BEFORE SERVICE AND MAINTENANCE, BE SURE SUPPLY CABLES ARE DEAD.

Always use an appropriate voltage detector to verify that there is no voltage present.

After boiler has been in operation for some time, retighten electrical connections. To prevent breakdown, boiler should be checked annually. This check should contain the following points:

- Leakage control

Make a visual inspection of the boiler checking for signs of water leakage. Remove top cover and check on top of the pressure vessel for leakage from heating elements.

- Power checking

Check if circuit breakers have tripped. Check by resistance measurement if any heating elements are broken.

- Contactors

Check all individual contactors if they are in normal position. Undertake a visual inspection of all wiring to the contactors and check for signs of overheating or burning. Any noise from contactor indicates wear and requires a thorough check. Be aware that burnt contactors may cause major damage.

- Electrical connections

Retighten all electrical connections on fuse holders, contactors and heating elements.

- Temp.controller

Check if temp.controller connect or disconnect power steps when adjusting preset temp. up and down. By entering service menu connection of power groups/contactors can be checked.

- Safety temp.limiter

Check safety temp.limiter. This can be done by switching off circulation pump or close valves. The boiler will then soon reach release temp. Safety temp. limiter must be manually reset.

Note!

SERVICE AND MAINTENANCE SHOULD ONLY BE CARRIED OUT BY QUALIFIED PERSONNEL

Tightening torques for contactors:

Contactors, type	Connection screw	Tightening torque
AF9, AF12, AF 16	M3,5	1,5 Nm
AF26, AF30, AF 38	M4	2,5 Nm
AF40, AF52, AF 65	M6	4 Nm

Tightening torques for circuit breakers:

type	Connection screw	Tightening torque
MS132/10	M3,5	1,2 Nm
MS132/12 - 16	M4	1,5 Nm
MS132/20 - 32	M4	2 Nm
XT1	M6	6 Nm

Tightening torque for heating element: M4 - 1,2 Nm
M12 – 15 Nm

Troubleshooting

NOTE! TROUBLESHOOTING MUST ONLY BE EXECUTED BY QUALIFIED PERSONNEL

FAILURE	DISPLAY TEXT	POSSIBLE CAUSE OF TROUBLE	CONTROL /REPAIR
BOILER "dead"		Control voltage missing	Boiler needs separate control voltage
		Fuse/s for control voltage broken	Check fuses and replace if required
NO POWER	Temp 30.0 (80)°C StepS 0 (0)	External start signal missing	Check external signal. (See terminal 1 & 2 on -X1)
	Temp 30.0 (80)°C StepE 0 (0)	External signal for power control missing	Check external signal
	TempE 20.0 (20)°C Power 0kW	External signal for temperature control missing	Check external signal
	Temp 0.0 (80)°C Error Temp	Defect temp.sensor	Change temp.sensor and Replace if required
BOILER STOPS AT STEP 3 (Alarm diode is flashing)	Temp 30.0 (80)°C Alarm Power	Connecting box mounted on left side without moving transformer	Transformer must be mounted on same side as connecting box
	Temp 30.0 (80)°C Alarm Power	Safety temp.limiter has tripped	Reset safety temp.limiter (STB) on front panel
	Temp 30.0 (80)°C Alarm Power	Main switch off or broken fuses	Check switch board/fuses Replace if required
LITTLE HEAT FROM BOILER	Temp 50.0 (80)°C Step 4 (4)	Maximum power limited from outside	Check external signals from a central monitoring system
	TempU 30.0 (30)°C Power 0kW	Check if boiler is limited from outdoor compensator	Check curves for outdoor compensation
		Defect heating elements, fuses, contactors	Check heating elements, fuses, contactors and replace if required
STB, safety temp.limiter released (Display shows "Alarm Power")	Temp 30.0 (80)°C Alarm Power	circulation in boiler	Check pump/valves
		Burned contactor	Check contactors and replace if required
LEAKAGE		Loose screws for heating element	Tighten screws
		Gasket for heating element	Replace if required
		Defect heating element	Replace if required

Circuit diagram MB 35 – 150 kW

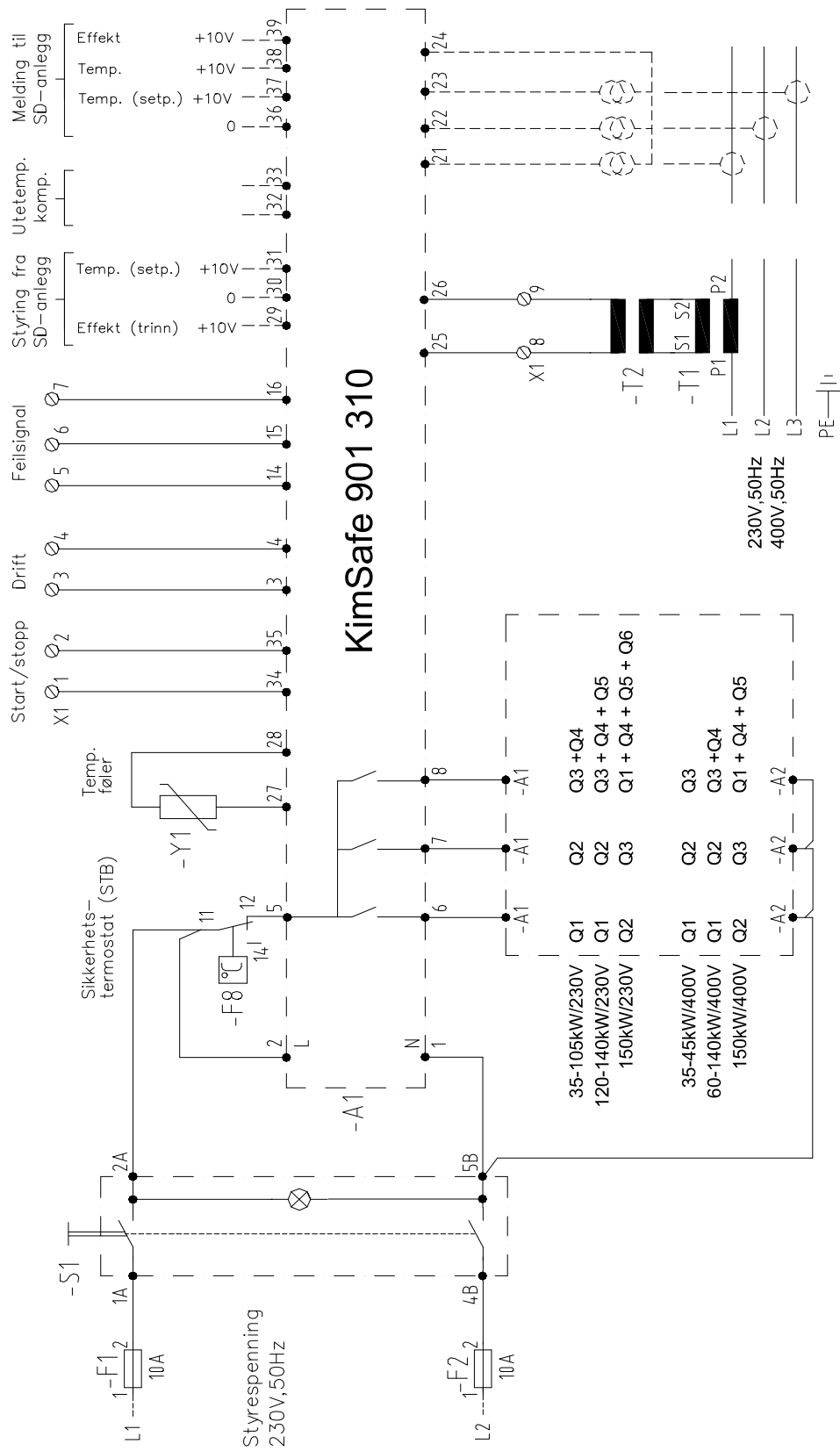

Power circuit MB 35-150 kW

MB 35kW/45kW

400V 

Apparatplate
Switch gear

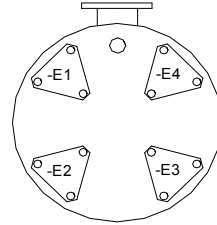
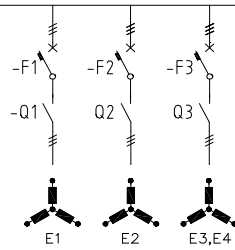

MB 60kW/75kW/90kW

400V 

Apparatplate
Switch gear

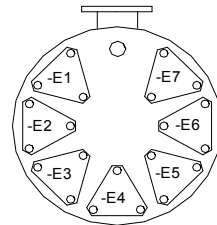
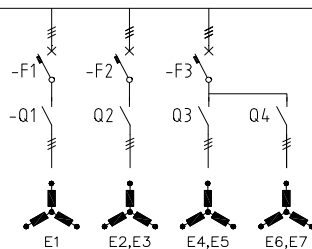

MB 105kW/120kW/140kW

400V 

Apparatplate
Switch gear

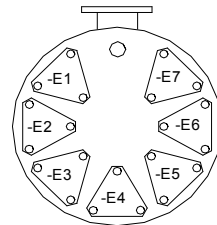
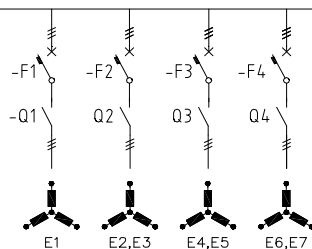

MB 150kW

400V 

Apparatplate
Switch gear

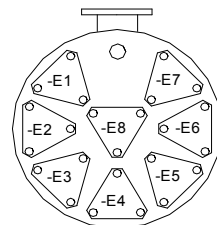
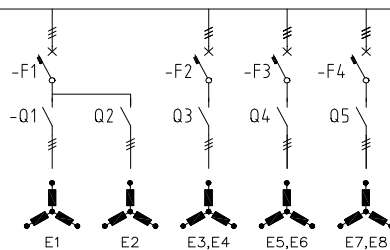

Temp.controller, terminals

KimSafe elektronisk temp.controller

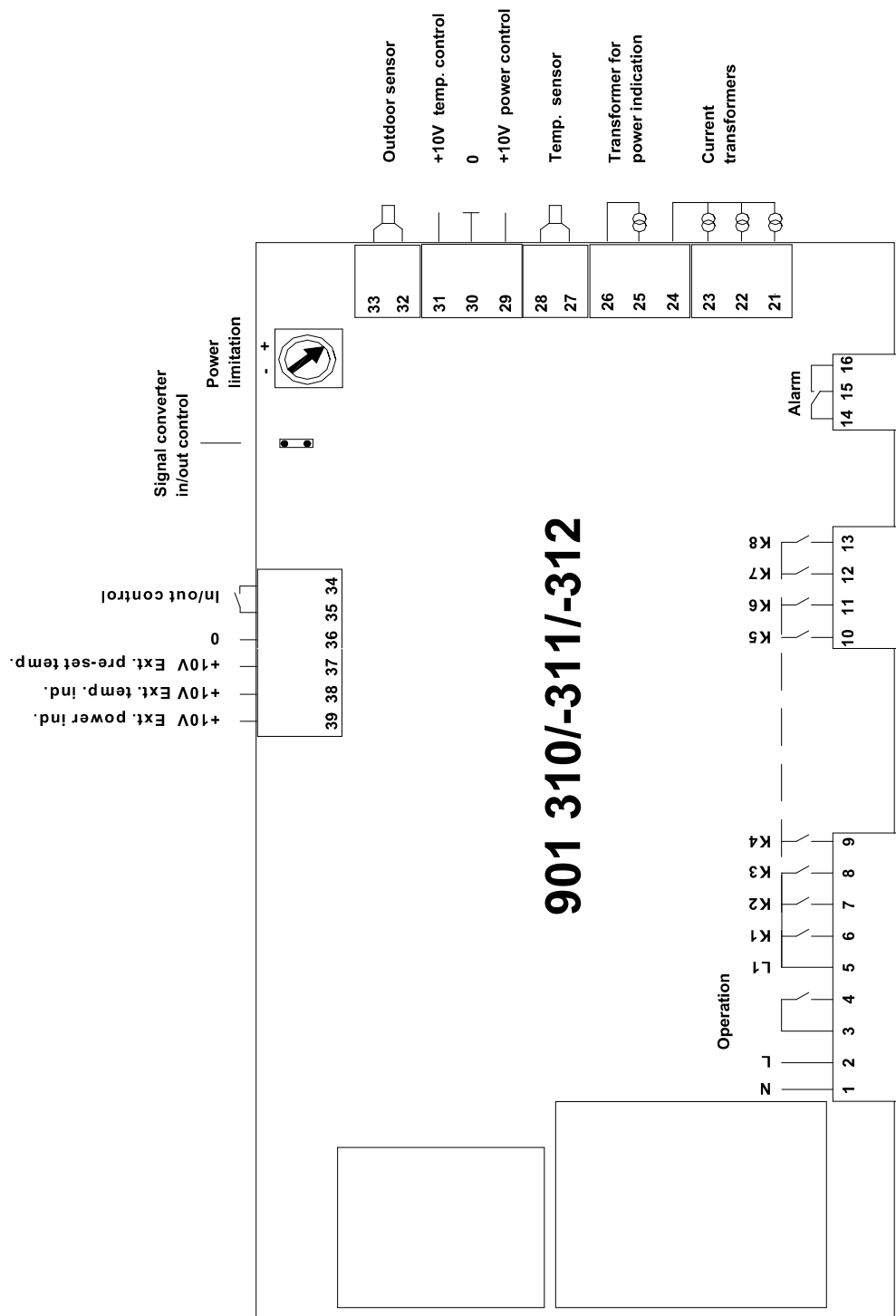

Spare parts MB 35 – 150 kW

Item	Article no.	Number																	
		35 kW		45 kW		60 kW		75 kW		90 kW		105 kW		120 kW		140 kW		150 kW	
Heating element 5 kW	6613 0001-K	1																	
Heating element 6 kW	6613 0001-P		1																
Heating element 7,5 kW	6613 0001-AR					2													
Heating element 9 kW	6613 0001-N					5	1												
Heating element 10 kW	6672 0242-A	3					3		3										1
Heating element 12 kW	6613 0001-G			2			3												
Heating element 15 kW	6672 0242-D		1							4		7		4					
Heating element 20 kW	6672 0242-G													3		7			7
Gasket	2152 0022-4	4	4			7	7		7	7	7	7	7	7	7	7	7	7	8
Temp.controller 7-steps	901 310	1	1	1	1	1	1	1	1	1	1	1	1	1	1	1	1	1	1
Sensor temp.controller	200 232	1	1	1	1	1	1	1	1	1	1	1	1	1	1	1	1	1	1
ON/OFF-switch	6672 0235-3	1	1	1	1	1	1	1	1	1	1	1	1	1	1	1	1	1	1
Safety temp.limiter (STB)	6672 0235-1	1	1	1	1	1	1	1	1	1	1	1	1	1	1	1	1	1	1
		230 V	400 V	230 V	400 V	230 V	400 V	230 V	400 V	230 V	400 V	230 V	400 V	230 V	400 V	230 V	400 V	230 V	400 V
Contactora AF12	41 175 16		1		1														
Contactora AF16	41 175 32	1	1	1	1	1	1		1										
Contactora AF26	41 175 48	1	1	1	1	1	3	1	1		2		1		1			1	2
Contactora AF30	41 175 56	2								1		1	3	1					
Contactora AF40	41 175 75			2		3			2	1	2		1	3	2	3	1	3	2
Contactora AF52	41 175 80							3					3				2		2
Contactora AF65	41 175 86									2									
Contactora AF80	41 175 92													2					
Contactora AF116	41 176 10															2		2	2
Fuse control voltage 10 A	6672 0235-27	2	2	2	2	2	2	2	2	2	2	2	2	2	2	2	2	2	2
Circuit breaker MS132/10-16	43 640 80	1	2	1	1		1		1										
Circuit breaker MS132/16-20	43 640 81				1														
Circuit breaker MS132/20-25	43 640 82					1		1			1		1		1				
Circuit breaker MS132/25-32	43 640 83	1	1	1			1										1		
Circuit breaker XT1-32	067 411																		
Circuit breaker XT1-40	067 412								1	1	1	1		1					
Circuit breaker XT1-50	067 413				1	1	1						3						1
Circuit breaker XT1-63	067 414	1						1		1	1				3	1	3		3
Circuit breaker XT1-80	067 415			1					1		1	3						1	
Circuit breaker XT1-100	067 416					1								3					
Circuit breaker XT1-125	067 417							1								3			3
Circuit breaker XT1-160	067 418									1									
Transformer Natek	200 018	1	1	1	1	1	1	1	1	1	1	1	1	1	1	1	1	1	1
Transformer 100/5 A	6672 0235-50	1	1		1		1												
Transformer 200/5 A	6672 0235-51			1		1		1	1		1		1		1		1		
Transformer 300/5 A	6672 0235-53									1		1							1
Transformer 400/5 A	6672 0235-54													1		1			1

Notes